

# ČEGRTALJKA

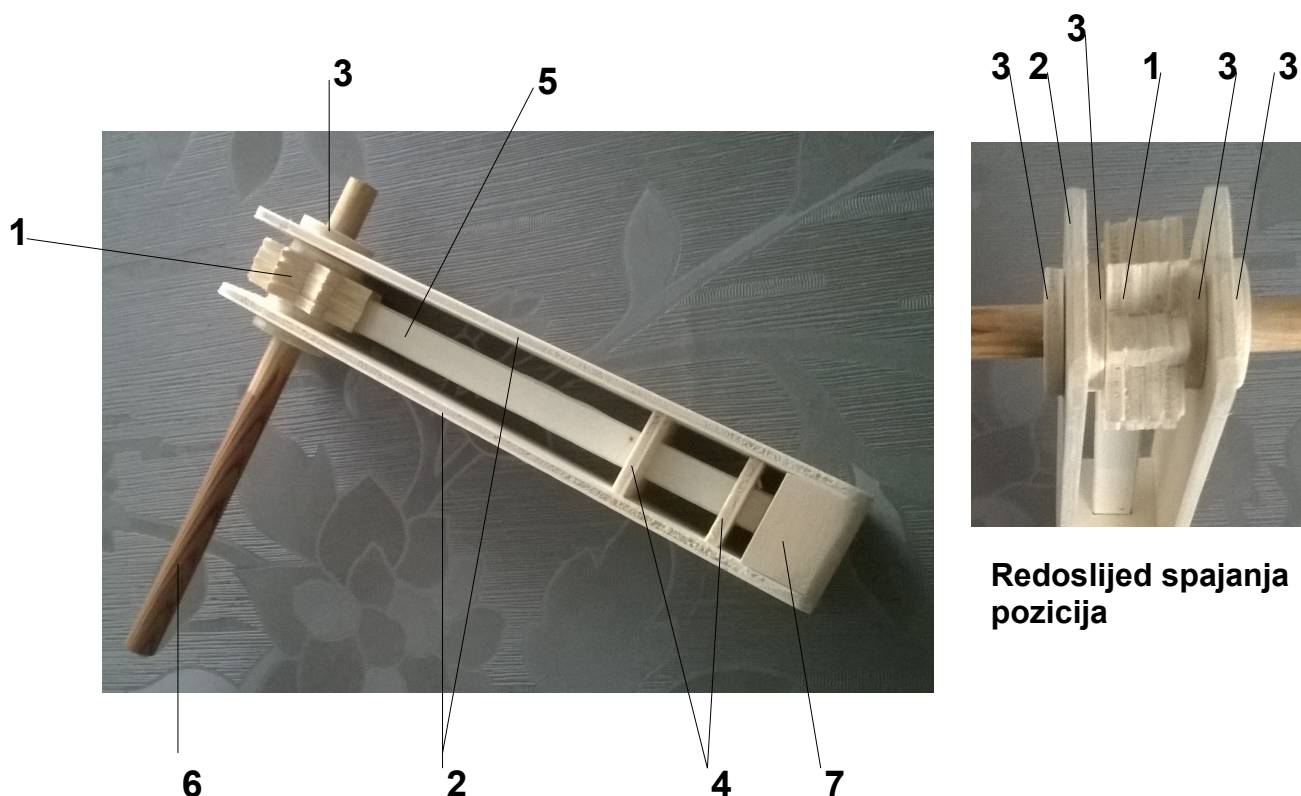

Čegrtaljka je igračka koja služi poljoprivrednicima za zaštitu uroda od ptica. Poznata je i kao navijački rekvizit. Sastoji se od tri osnovna djela: ručica, pero za udaranje i tijelo čegrtaljke sa zupčanikom.

7.	Drveni kvadar	Drvo	1	40 x 22 x 15
6.	Štapić za držanje čegrtaljke	Drvo – okrugli štapić	1	150 x Ø10
5.	Pero za udaranje	Šperploča ili plastika	1	130 x 10 x 3
4.	Držači pera za udaranje	Šperploča	2	30 x 30 x 4
3.	Graničnici - podlošci	Šperploča	4	Ø23 X 4
2.	Vanjske strane	Šperploča	2	185 x 40 x 4
1.	Zupčanik	Šperploča	4	40 x 40 x 4
Broj poz.	Naziv poz.	Materijal	Komada	Dimenzije (mm)
ČEGRTALJKA		Mjerilo: M1:1	Pripremio: Ivan Rajs, prof.	Školska god.: 2016./2017.

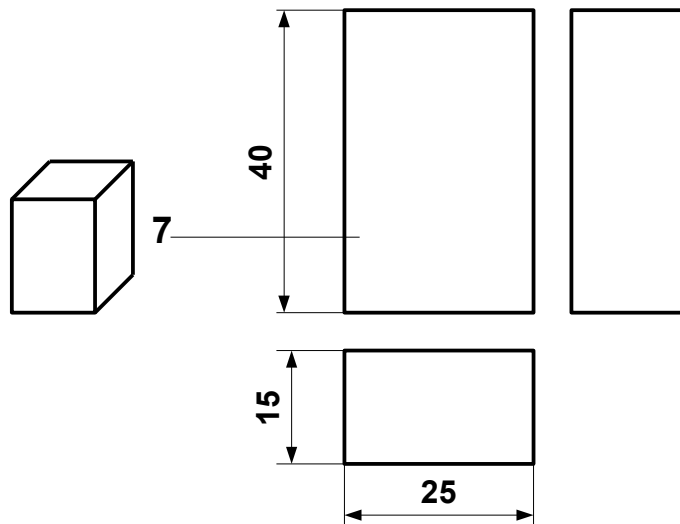
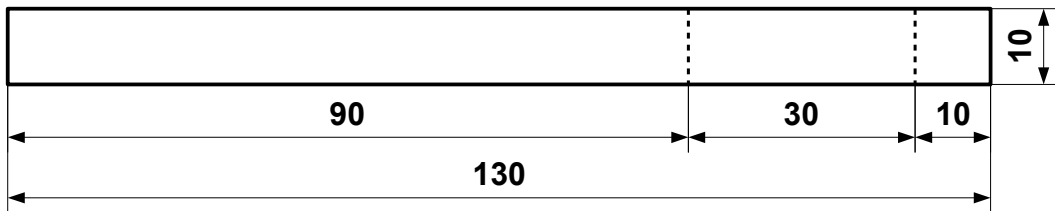
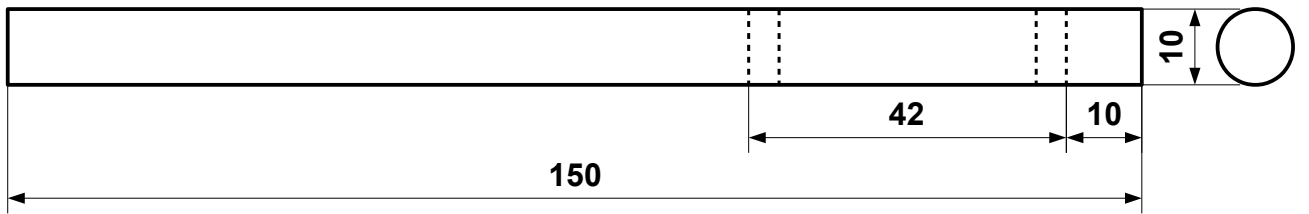
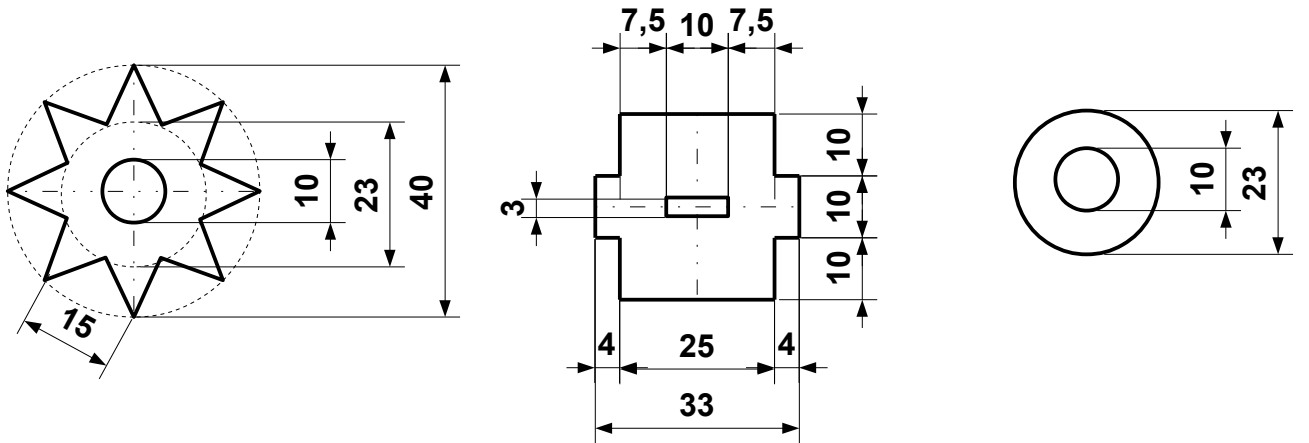
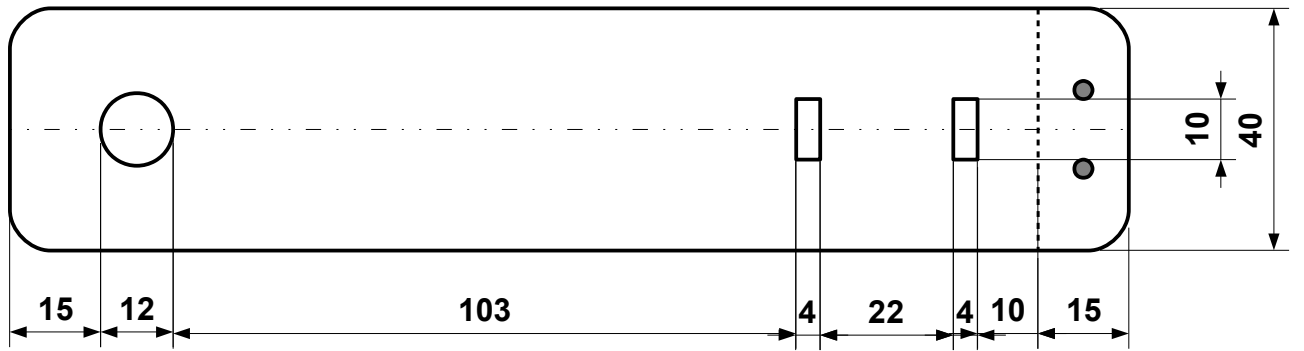

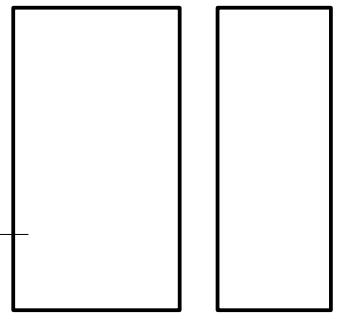
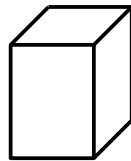
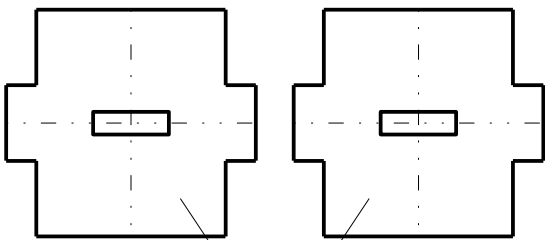
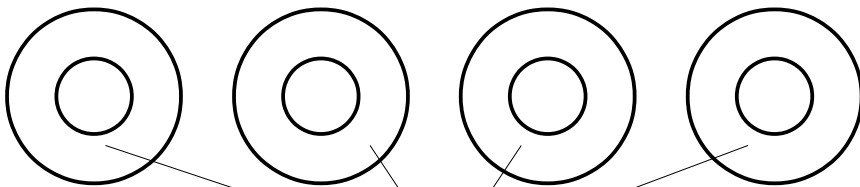
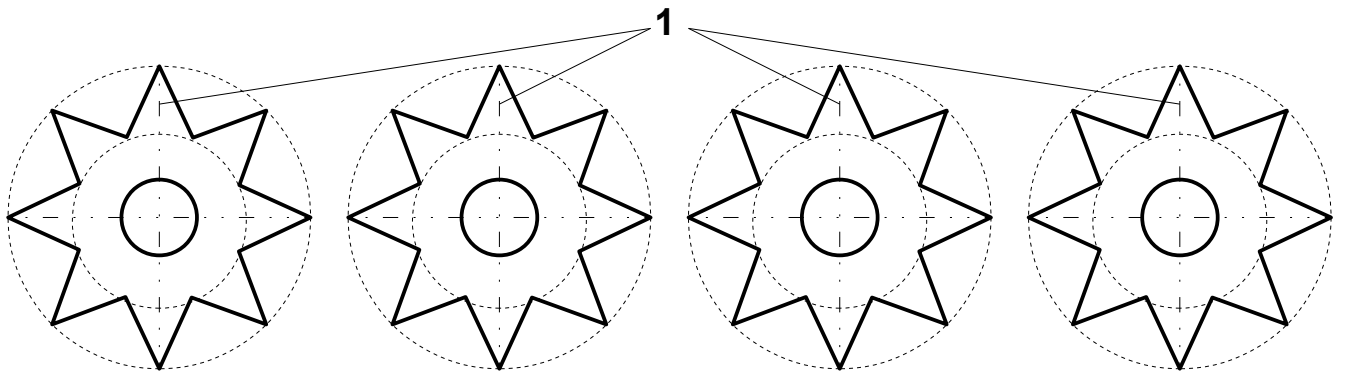

2

3

4

7

5

6